



**Waxman Ceramics**  
Architectural Tiles



YE

**series**

**YEOVIL**

Unglazed Porcelain  
EN14411 Annexe G Group Bla

EPD 



# YE Series

Glazed Porcelain

# YEOVIL

## COLOURS



YE-80  
Beige



YE-81  
Black



YE-82  
Grey



YE-83  
Sand



YE-84  
Pearl



YE-85  
White

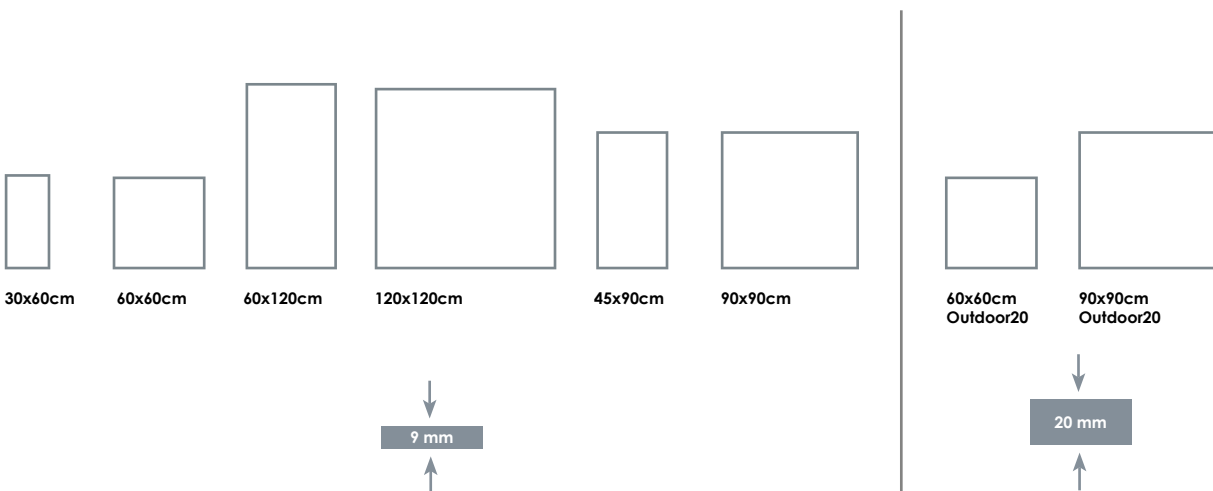

# YE Series

Glazed Porcelain

YEOVIL

## SIZES

SIZE	30x60cm 9mm	60x60cm 9mm	60x120cm 9mm	45x90cm 9mm	90x90cm 9mm	120x120cm 9mm	60x60mm 20mm	90x90mm 20mm
YE-80 Beige	● ●	● ● ● ●	● ● ● ● ● ● ● ●	●	● ● ●	● ●	●	●
YE-81 Black	● ●	● ● ● ●	● ● ● ● ● ● ● ●	●	● ● ●	● ●	●	●
YE-82 Grey	● ●	● ● ● ●	● ● ● ● ● ● ● ●	●	● ● ●	● ●	●	●
YE-83 Sand	● ●	● ● ● ●	● ● ● ● ● ● ● ●	●	● ● ●	● ●	●	●
YE-84 Pearl	● ●	● ● ● ●	● ● ● ● ● ● ● ●	●	● ● ●	● ●	●	●
YE-85 White	● ●	● ● ● ●	● ● ● ● ● ● ● ●	●	● ● ●	● ●	●	●

● Natural ● Natural Silk ● Grip ● Antique ● Antique Silk ● Rigata ● Diagonal

## FINISHES

**Natural**

**Natural Silk**

**Grip Outdoor20**

**Antique**

**Antique Silk**

**Rigata**

**Diagonal**

Natural		
Slip Resistance		
	R10	+36

Grip		
Slip Resistance		
	R11	+36

Antique		
Slip Resistance		
	R10	+36
	B	

Rigata		
Slip Resistance		
	R10	+36
	B	

Diagonal		
Slip Resistance		
	R10	+36
	B	

## SPECIAL PIECES

**Bullnose**



7x60cm  
7x90cm

**Step Tread**

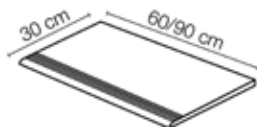

30x60cm  
30x90cm

**Step Edge**

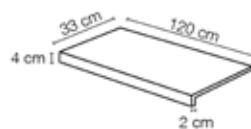

120x33cm

**Step**

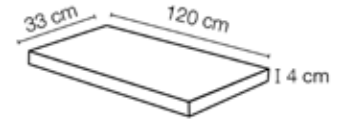

120x33cm

**Border**



33x60cm

**Border Outer Corner**

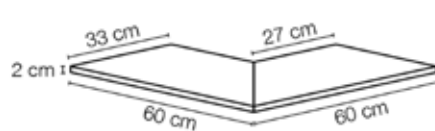

60x60cm

**Border Inner Corner**

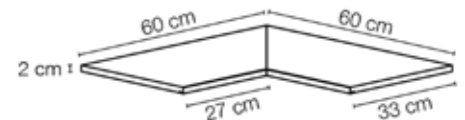

60x60cm



YE-80 Beige Natural Silk - 120x120cm



YE-80 Beige Natural Silk - 120x120cm



YE-80 Beige Natural Silk 120x120cm / Natural 90x90cm



YE-81 Black & YE-85 White 60x120cm





YE-82 Grey Natural 60x120cm / Grip Outdoor20 90x90x20cm



YE-82 Grey Natural 60x120cm



YE-82 Grey Natural 120x120cm



YE-82 Grey Natural 120x120cm / Rigata 60x120cm



YE-82 Grey Natural 120x120cm / Rigata 60x120cm



YE-82 Grey Natural 120x120cm / Rigata 60x120cm / YE-85 White Natural 60x120cm



YE-83 Sand Antique - 90x90cm



YE-83 Sand Natural - 120x120cm / YE-80 Beige Diagonal - 60x120cm





YE-83 Sand Natural - 120x120cm / YE-80 Beige Diagonal - 60x120cm



YE-83 Sand Natural - 120x120cm / YE-80 Beige Diagonal - 60x120cm



YE-84 Pearl Diagonal - 60x120cm



YE-84 Pearl Natural - 60x120cm



YE-84 Pearl Natural - 60x120cm



- ◀ SWIMMING POOL
- ◀ HYDROTHERAPY
- ◀ ROMAN BATHS



YE-84 Pearl Natural & Diagonal - 60x120cm / YE-82 Grey Natural - 120x120cm



YE-85 White Natural 90x90cm / Grip Outdoor20 90x90x20cm



YE-85 White Antique - 60x60cm / Diagonal 60x120cm















YE-85 White Diagonal 60x120cm



YE-80 Beige Antique / Natural / YE-81 Black Natural / YE-82 Grey Rigata / YE-84 Pearl Diagonal

## TECHNICAL FEATURES

		Norm Standards	Test Results																								
	<b>Product Classification</b>	UNI EN 14411	Unglazed Porcelain EN14411 Annexe G Group B1a																								
	<b>Dimensional and surface quality</b>	UNI EN ISO 10545-2	Very low tolerance																								
	<b>Water absorption</b>	UNE-EN-ISO 10545-3	< 0,1%																								
	<b>Flexural strength</b>	UNI EN ISO 10545-4	45 N/mm <sup>2</sup>																								
	<b>Frost resistance</b>	UNI EN ISO 10545-12	Resistant																								
	<b>Resistance to acids and alkalis (except hydrofluoric acid)</b>	UNI EN ISO 10545-13	A																								
	<b>Wear and abrasion resistance</b>	UNI EN ISO 10545-6	≤ 150 mm <sup>3</sup>																								
	<b>Thermal shock resistance</b>	UNI EN ISO 10545-14	Resistant																								
	<b>Slip resistance</b>		<table border="1"> <thead> <tr> <th></th> <th>DIN 51130</th> <th>DIN 51097</th> <th>PTV</th> </tr> </thead> <tbody> <tr> <td>Natural</td> <td>R10</td> <td></td> <td>+36</td> </tr> <tr> <td>Diagonal</td> <td>R10</td> <td>B</td> <td>+36</td> </tr> <tr> <td>Antique</td> <td>R10</td> <td>B</td> <td>+36</td> </tr> <tr> <td>Rigata</td> <td>R10</td> <td>B</td> <td>+36</td> </tr> <tr> <td>Grip</td> <td>R11</td> <td></td> <td>+36</td> </tr> </tbody> </table>		DIN 51130	DIN 51097	PTV	Natural	R10		+36	Diagonal	R10	B	+36	Antique	R10	B	+36	Rigata	R10	B	+36	Grip	R11		+36
	DIN 51130	DIN 51097	PTV																								
Natural	R10		+36																								
Diagonal	R10	B	+36																								
Antique	R10	B	+36																								
Rigata	R10	B	+36																								
Grip	R11		+36																								
	<b>colour resistance to sunlight exposure</b>	DIN 51094	No change of colours																								
	<b>Stain resistance</b>	UNI EN ISO 10545-14	Class 5																								

# Waxman Ceramics Architectural Tiles

---

**Head Office**                      **01422 377123**

Grove Mills  
Elland  
West Yorkshire  
HX5 9DZ  
England

Email            [info@waxmanarchitectural.co.uk](mailto:info@waxmanarchitectural.co.uk)  
Web              [www.waxmanarchitectural.co.uk](http://www.waxmanarchitectural.co.uk)

**Waxman Ceramics Architectural Tiles is a division of Waxman Ceramics Ltd - Part of the Waxman Group**

The information contained within this document is, to the best of our knowledge, accurate at the time of production. We reserve the right to modify this document at any time. Whilst every attempt has been made to accurately reproduce colours and textures, images used within this document are only intended as a guide. Please refer to actual product samples before specifying or ordering.